



■ Features

- 5"×3" miniature size
- Universal AC input / Full range
- Built-in active PFC function
- Medical safety approved
(2 x MOPP between primary to secondary)
- Suitable for BF application with appropriate system consideration
- Low leakage current <math><200\mu\text{A}</math>
- No load power consumption<math><0.5\text{W}</math> by PS-ON control
- High efficiency up to 93%
- Protections: Short circuit / Overload / Over voltage / Over temperature
- Cooling by free air convection for 200W and 300W with 20.5CFM forced air
- Built-in 12V/0.5A fan supply
- Standby 5V @1A with fan, 0.6A without fan
- LED indicator for power on
- 3 years warranty

■ Applications

- Oral irrigator
- Hemodialysis machine
- Medical monitors
- Sleep apnea devices
- Pumps machine

■ Description

RPS-300 is a 300W highly reliable green PCB type medical power supply with a high power density on the 5" by 3" footprint. It accepts 90~264VAC input and offers various output voltages between 12V and 48V. The working efficiency is up to 93% and the extremely low no load power consumption is down below 0.5W. The extremely low leakage current is less than 200 μA . In addition, it conforms to international medical regulations (2*MOPP) and EMC EN55011, perfectly fitting all kinds of BF rated "patient contact" medical system equipment. RPS-300 series also offers the enclosed style model (RPS-300-C).

■ Model Encoding

RPS - 300 - 12 - C

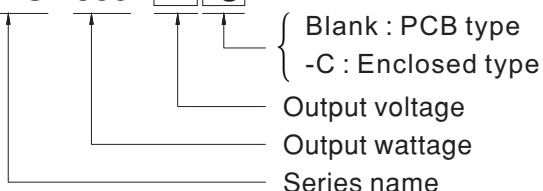



SPECIFICATION

MODEL	RPS-300-12□	RPS-300-15□	RPS-300-24□	RPS-300-27□	RPS-300-48□	
OUTPUT	DC VOLTAGE	12V	15V	24V	27V	48V
	RATED CURRENT (20.5CFM)	25A	20A	12.5A	11.12A	6.25A
	CURRENT RANGE (convection)	0 ~ 16.67A	0 ~ 13.33A	0 ~ 8.33A	0 ~ 7.4A	0 ~ 4.17A
	CURRENT RANGE (20.5CFM)	0 ~ 25A	0 ~ 20A	0 ~ 12.5A	0 ~ 11.12A	0 ~ 6.25A
	RATED POWER (convection)	200W	200W	199.9W	199.8W	200.2W
	RATED POWER (20.5CFM)	300W	300W	300W	300.24W	300W
	RIPPLE & NOISE (max.) Note.2	120mVp-p	120mVp-p	150mVp-p	200mVp-p	250mVp-p
	VOLTAGE ADJ. RANGE	Main output:11.4 ~ 12.6V	Main output:14.25 ~ 15.75V	Main output:22.8 ~ 25.2V	Main output:25.65 ~ 28.35V	Main output:45.6 ~ 50.4V
	VOLTAGE TOLERANCE Note.3	±3.0%	±3.0%	±2.0%	±2.0%	±2.0%
	LINE REGULATION	±0.5%	±0.5%	±0.5%	±0.5%	±0.5%
	LOAD REGULATION	±1.0%	±1.0%	±1.0%	±1.0%	±1.0%
	SETUP, RISE TIME	250ms, 30ms/230VAC 3000ms, 30ms/115VAC at full load				
HOLD UP TIME (Typ.)	13ms/230VAC/115VAC at full load					
INPUT	VOLTAGE RANGE Note.4	90 ~ 264VAC 127 ~ 370VDC				
	FREQUENCY RANGE	47 ~ 63Hz				
	POWER FACTOR (Typ.)	PF>0.93/230VAC		PF>0.98/115VAC at full load		
	EFFICIENCY (Typ.)	90%	90%	92.5%	93%	93%
	AC CURRENT (Typ.)	3.5A/115VAC 1.8A/230VAC				
	INRUSH CURRENT (Typ.)	COLD START 40A/115VAC 80A/230VAC				
LEAKAGE CURRENT Note.5	Earth leakage current <250uA / 264VAC, Touch current <100uA/264VAC					
PROTECTION	OVERLOAD	105 ~ 135% rated output power Protection type : Hiccup mode, recovers automatically after fault condition is removed				
	OVER VOLTAGE	13.5 ~ 15V	16.2 ~ 18.5V	26 ~ 30V	29.5 ~ 33.5V	52 ~ 59.5V
	OVER TEMPERATURE	Protection type : (TSW1)Shut down o/p voltage, recovers automatically after temperature goes down Protection type : (TSW2)Shut down o/p voltage, re-power on to recover				
FUNCTION	5V STANDBY	5VSB : 5V@0.6A without fan, 1A with fan 20.5CFM ; tolerance ± 2%, ripple : 150mVp-p(max.)				
	FAN SUPPLY	12V@0.5A for driving a fan ; tolerance -15% ~ +10%				
	PS-ON INPUT SIGNAL	Power on: PS-ON = "Hi" or " > 2 ~ 5V" ; Power off: PS-ON = "Low" or " < 0 ~ 0.5V"				
	POWER GOOD / POWER FAIL	500ms>PG>10ms ; The TTL signal goes high with 10ms to 500ms delay after power set up ; The TTL signal goes low at least 1ms before Vo below 90% of rated value				
ENVIRONMENT	WORKING TEMP.	-30 ~ +70°C (Refer to "Derating Curve")				
	WORKING HUMIDITY	20 ~ 90% RH non-condensing				
	STORAGE TEMP., HUMIDITY	-40 ~ +85°C , 10 ~ 95% RH				
	TEMP. COEFFICIENT	±0.03%/°C (0 ~ 50°C)				
	VIBRATION	10 ~ 500Hz, 2G 10min./1cycle, 60min. each along X, Y, Z axes				
SAFETY & EMC (Note 6)	SAFETY STANDARDS	ANSI/AAMI ES60601-1, TUV EN60601-1, IEC60601-1 approved				
	ISOLATION LEVEL	Primary-Secondary: 2xMOPP, Primary-Earth:1xMOPP, Secondary-Earth:1xMOPP				
	WITHSTAND VOLTAGE	I/P-O/P:4KVAC I/P-FG:2KVAC O/P-FG:1.5KVAC				
	ISOLATION RESISTANCE	I/P-O/P, I/P-FG, O/P-FG:100M Ohms / 500VDC / 25°C / 70% RH				
	EMC EMISSION	Compliance to EN55011 (CISPR11), EN55022 (CISPR22) ,Conduction Class B ,Radiation Class A;EN61000-3-2,-3;				
EMC IMMUNITY	Compliance to EN61000-4-2,3,4,5,6,8,11, EN55024, EN60601-1-2, criteria A					
OTHERS	MTBF	160Khrs min. MIL-HDBK-217F (25°C)				
	DIMENSION	PCB type:127*76.2*35mm (L*W*H) ; Enclosed type:130*86.6*43mm (L*W*H)				
	PACKING	PCB type:0.37Kg; 36pcs/14.3Kg/1.03CUFT ; Enclosed type:0.563Kg; 24pcs/14.5Kg/0.77CUFT				
NOTE	<ol style="list-style-type: none"> All parameters NOT specially mentioned are measured at 230VAC input, rated load and 25°C of ambient temperature. Ripple & noise are measured at 20MHz of bandwidth by using a 12" twisted pair-wire terminated with a 0.1uf & 47uf parallel capacitor. Tolerance : includes set up tolerance, line regulation and load regulation. Derating may be needed under low input voltages. Please check the derating curve for more details. Touch current was measured from primary input to DC output. The power supply is considered a component which will be installed into a final equipment. All the EMC tests are been executed by mounting the unit on a 360mm*360mm metal plate with 1mm of thickness. The final equipment must be re-confirmed that it still meets EMC directives. For guidance on how to perform these EMC tests, please refer to "EMI testing of component power supplies." (as available on http://www.meanwell.com) 					

Block Diagram

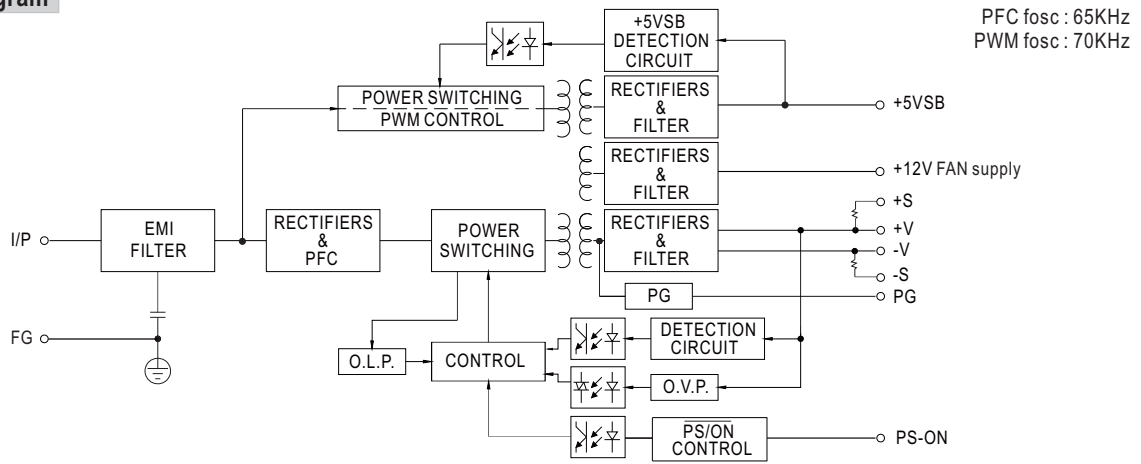

Derating Curve

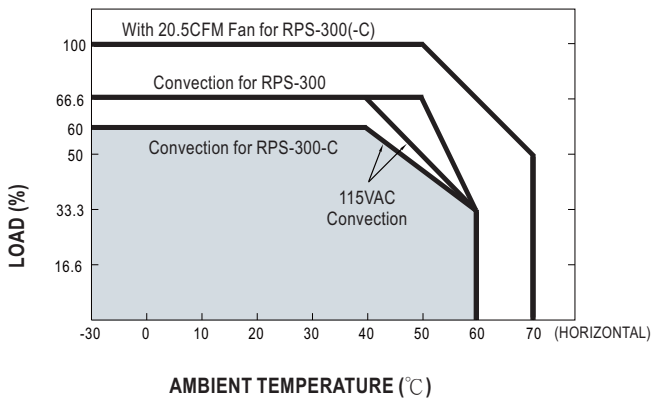

Output Derating VS Input Voltage

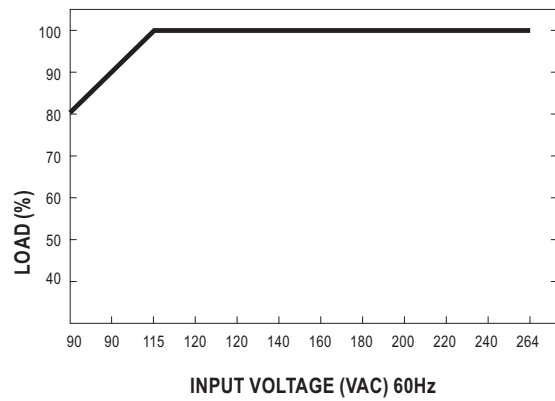

■ Mechanical Specification

Unit:mm

◎ RPS-300 (PCB type)

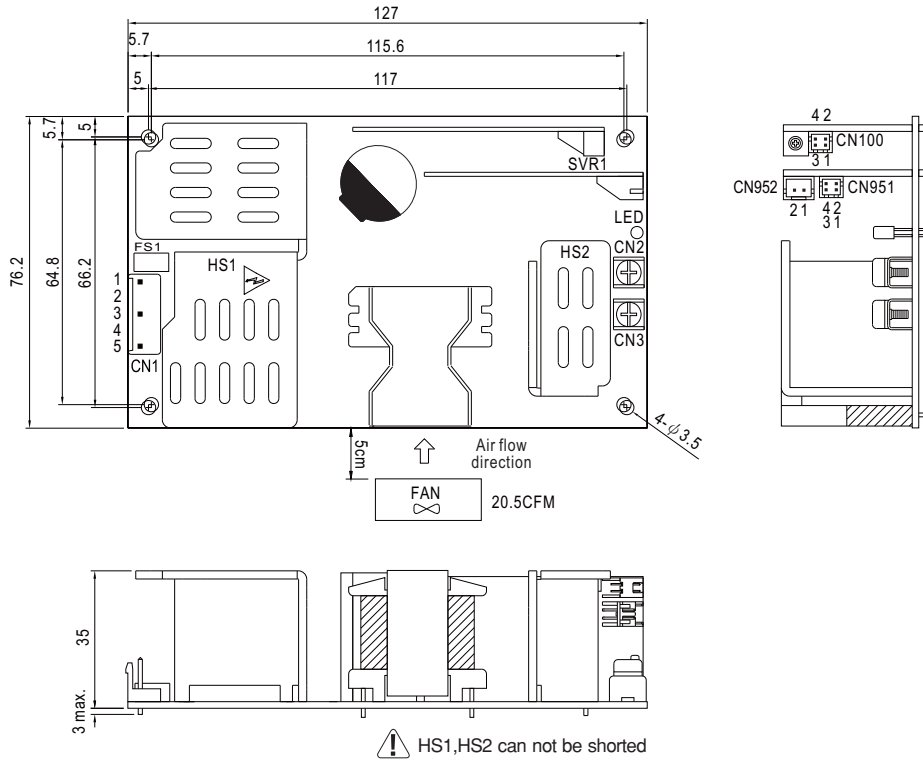

◎ RPS-300-C (Enclosed type)

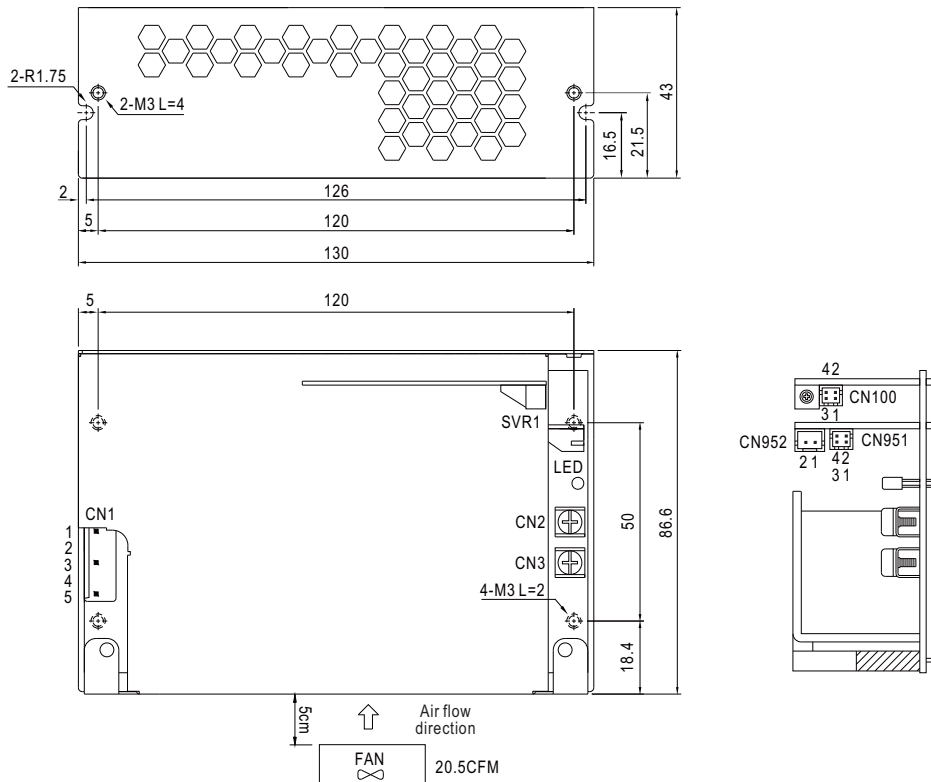

AC Input Connector (CN1) : JST B5P-VH or equivalent

Pin No.	Assignment	Mating Housing	Terminal
1	AC/N	JST VHR or equivalent	JST SVH-21T-P1.1 or equivalent
2,4	No Pin		
3	AC/L		
5	FG \pm		

DC Output Connector (CN2,CN3)

Pin No.	Assignment	Output Terminals
CN2	-V	M4 Pan HD screw in 2 positions
CN3	+V	Torque to 8 lbs-in(90cNm)max.

 1.HS1,HS2 cannot be shorted.

Function Connector(CN100):HRS DF11-4DP-2DS or equivalent

Pin No.	Status	Mating Housing	Terminal
1	-S	HRS DF11-4DS or equivalent	HRS DF11- ** SC or equivalent
2	+S		
3	DC COM		
4	PG		

Function Connector(CN951):HRS DF11-4DP-2DS or equivalent

Pin No.	Status	Mating Housing	Terminal
1	5VSB	HRS DF11-4DS or equivalent	HRS DF11- ** SC or equivalent
2,4	DC COM		
3	PS-ON		

FAN Connector(CN952) : JST S2B-XH or equivalent

Pin No.	Assignment	Mating Housing	Terminal
1	DC COM	JST XHP or equivalent	JST SXH-001T-P0.6 or equivalent
2	+12V		

※Note : 1. The FAN supply is designed to serve as the source of the additive external fan for the cooling of the power supply, enabling the full load delivery and assuring the best life span of the product. Please do not use this FAN supply to drive other devices.

2.The Enclosed type(-C type) model is not suitable for configuration within a Class II (without FG) system but suggested within a Class I (with FG) system.

■ Installation Manual

Please refer to : <http://www.meanwell.com/webnet/search/InstallationSearch.html>